

USER MANUAL

Silicone Neon Strip

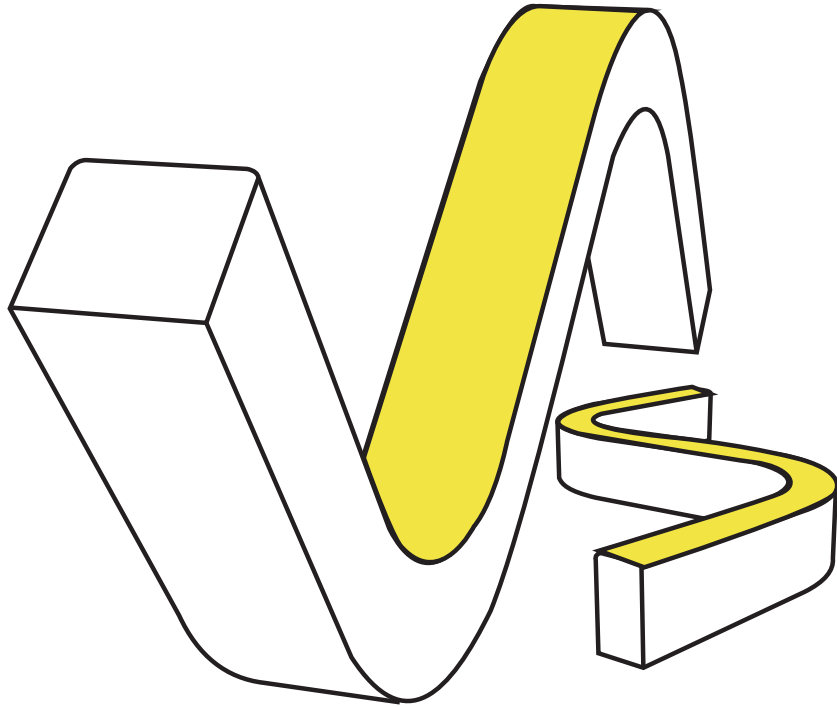

Please read the manual carefully before installation and application, and use the product in the correct way.
 Instructions on accessories are included in the manual.
 Please properly maintain the manual after reading and understanding it for convenient reference by all users of the product in the future.



Tel : +86-15920391130
 E-mail : info@mylikeled.com
 Web : www.mylikeled.com

Precautions before installation

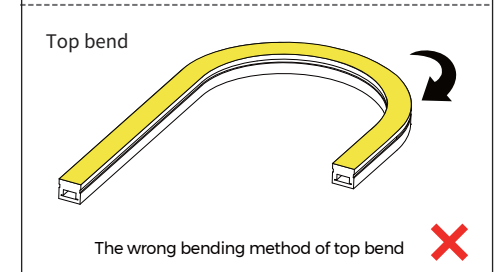
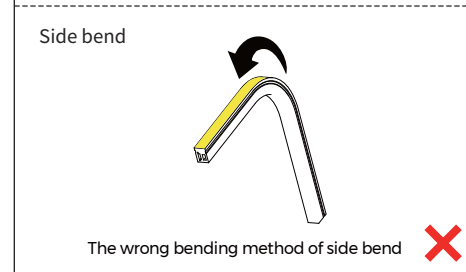
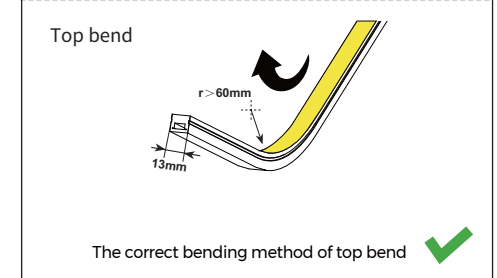
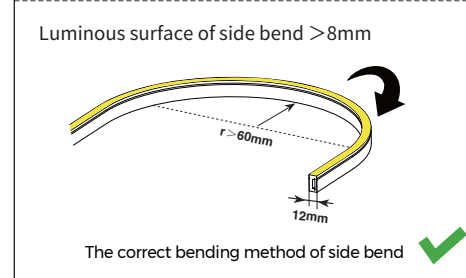
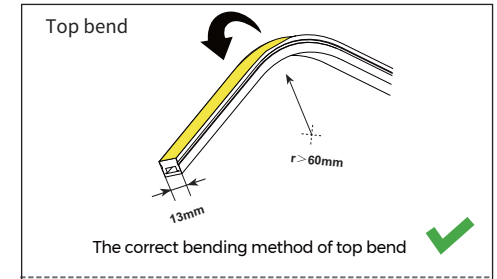
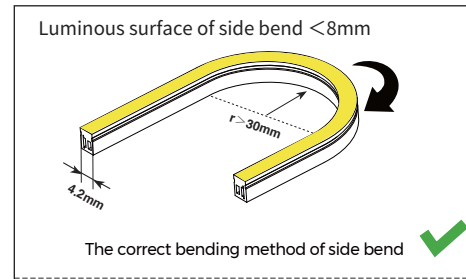
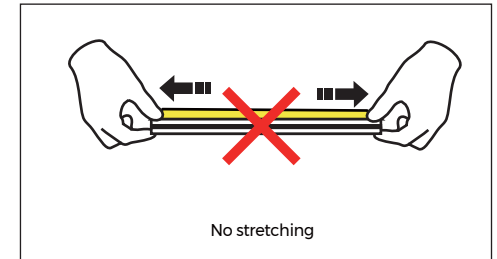
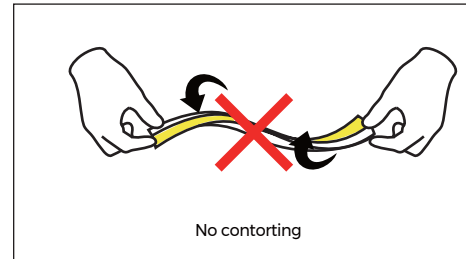
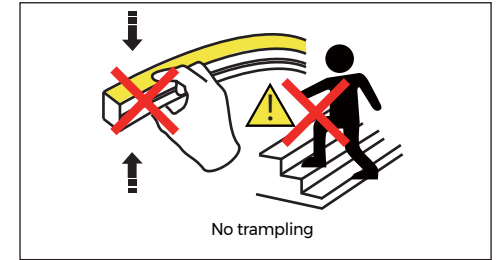
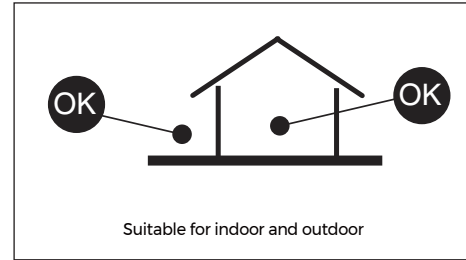

Straight installation

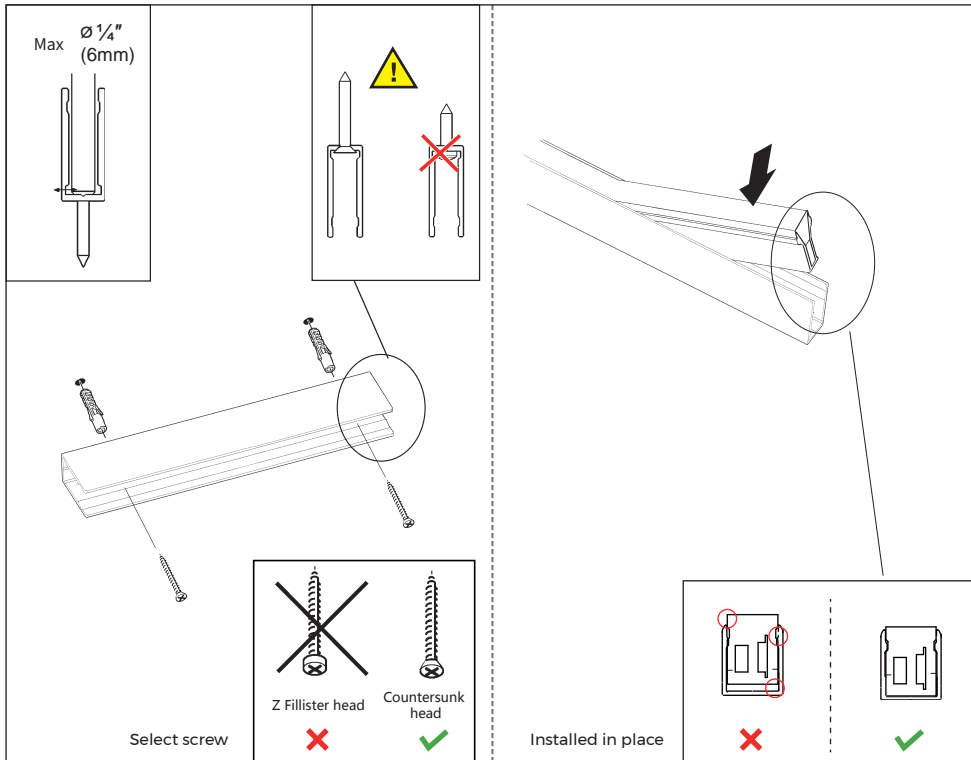
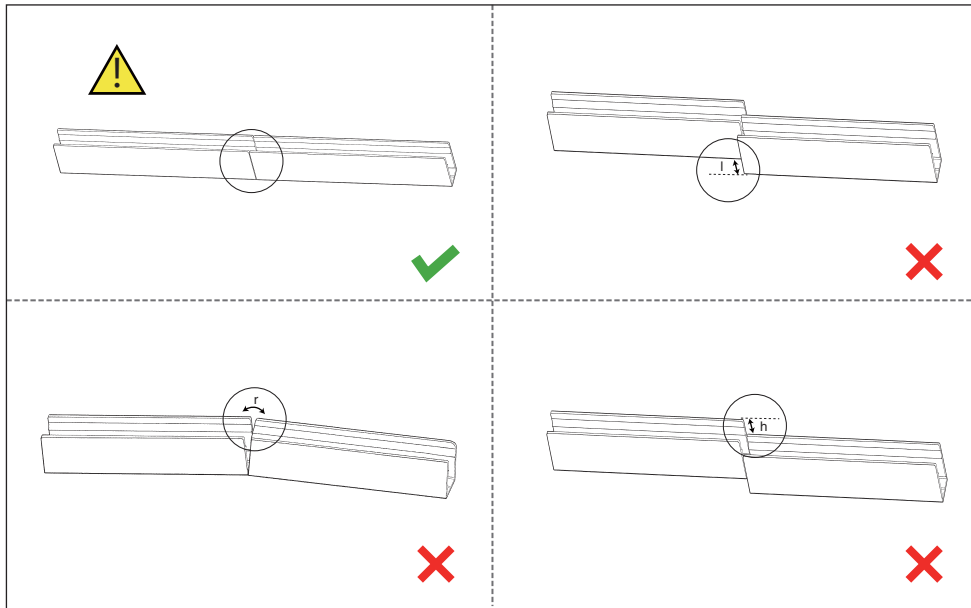

Wiring diagram

Turn off the power before wiring

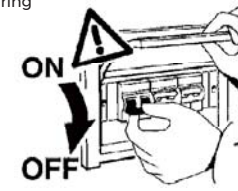

Non-dimming connection mode

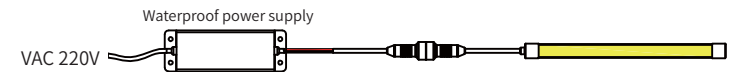

Dimming connection mode

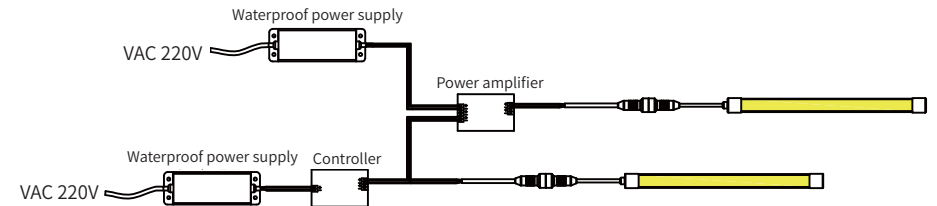

Notices

1. The products are subject to thermal expansion as a result of the changes in temperature to which they are subject. This thermal expansion must be taken into account in installations subject to a wide range of temperature.
2. Clean the screens exclusively using water and methylated spirits.
3. IP65/IP67 protection on the product and the continuous line system with IP68 connectors.
4. Product is not suitable for use in swimming pools and fountains

Installation of clip

1. Use screws to fix the clips or carriers on the mounting position

▲ Clip: 3 clips can be used for 1m:

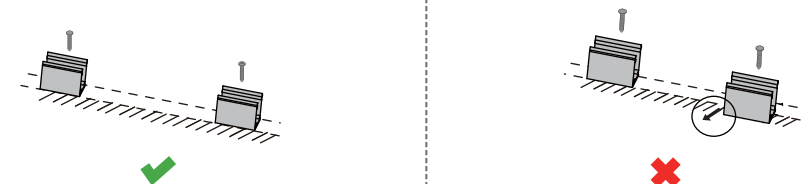

Installation of carrier

1. When installing the LED strip, install it from both ends at the same time, installation from one direction is prohibited.

2. Use tool to disassemble carefully, and do not pull the LED strip directly.

⚠️ If the length of LED strip is over 2m, it is recommended to install by two persons.

> 2m

⚠️ If the length of LED strip is over 2m, it is recommended to disassemble by two persons.

> 2m

Cutting method

Operations of LED strip cutting, welding and plug installing

1. Cut out the LED strip to required length

⚠️ The minimum cutting unit should be subject to the mark of LED strip

2. Expose the copper foil of the LED strip (cut the rubber mass at the side of the LED strip)

3. Connect the wires with the LED strip (pay attention to positive and negative poles)

4. Put the plug with a hole into the wires and inject glue into the plug

⚠️ The amount of glue should be 1/3 to 1/2 of the plug

5. Push the plug into the LED strip

⚠️ After injecting glue, the LED strip should be placed horizontally for two hours until the plug surface is dry, and then to finish the operation of plug end.

6. Fill the end of LED strip with filler, then push the plug into the end of LED strip

⚠️ After injecting glue, the LED strip should be placed horizontally for two hours until the LED strip is dry, then finish the next operation, and it will be completely dry after 24 hours

Notices

- Only the parts with cutting marks can be cut when it is necessary to cut the silicone neon strip according to the on-site installing length;
- Use a 24V DC isolated power supply to drive the silicone neon strip and the ripple wave of constant voltage source shall be less than 5%. It is not allowed to use RC voltage reduction or non-isolated power supply to drive the silicone neon strip.
- When connecting silicone neon strips in series, one test should be made for each section to promptly find out whether the positive and negative poles are incorrectly connected;
- Attention should be paid to the positive and negative poles of the wires during installation and whether the power supply conforms to required voltages to avoid damages.
- Silicone neon strip should be placed in a dry and sealed environment. It is suggested that the storage period cannot be too long. Working temperature: -20°C~ +45°C; storage temperature: 0°C~ +60°C
- LED has unilateral conductivity. If a power line with a DC/AC converter is used, an energization test should be done first after connecting power supply to ensure that the positive and negative poles are connected correctly;
- In actual applications, 20% of the power supply shall be kept (only 80% of the power is used) to guarantee that sufficient voltage is available to drive the product;
- Attention shall be paid to safe operation. After powering on, it is not allowed to touch the AC power supply to avoid an electric shock;
- On the premise of required direction (the top view is not same as the side view), please do not bend the strip into an arc with a diameter less than 60mm to ensure the longevity and reliability.

Product Warranty Description

- A warranty period of three years is provided for products in normal use. For any faults arising during the period that are confirmed to be quality related by inspection of the company, a product of the same model will be replaced for free.
- The warranty does not cover any of the following:
 - Any product damage due to usage not allowed in the instructions;
 - Any product damage due to disassembling or wrong operations by the user;
 - Severe appearance damage or deformation of the product.