

LED STRIP SMD2835 140LED/M IP65
140 灯/米 防水霓虹灯带 6*12mm 侧发光系列

Customer Name/客户名称: _____

Standard Model/规格型号: LNTS8PW140NEON4-M1-D24-T0612

Product description /产品描述: SMD2835 正白 6*12mm 防水霓虹灯带

CUSTOMER/客户		
CONFIRMER 设计/开发/采购	CHECKER 审核	APPROVER 批准
SUPPLIER/供货商		
拟制 FICTION	审核 CHECKER	批准 APPROVER
黄华波		

PRODUCT PICTURE 产品图片



Features 特点

※High light efficiency, low temperature;
※光效高、温升低;

※High CRI, High brightness;
※高显值、高亮度;

※It has good linear effect and can replace the traditional light source;
※具有良好的线性效果，可取代传统的光源;

※Good attenuation function, long service life and good bending resistance;
※良好的衰减功能，使用寿命长，耐弯折性好;

※Products can be cut position, can also be customized according to customer needs;
※产品设有可剪位，也可根据客户需求定制;

Minimum bending radius 最小弯曲半径



最小弯曲半径 $R_{min}=50mm$

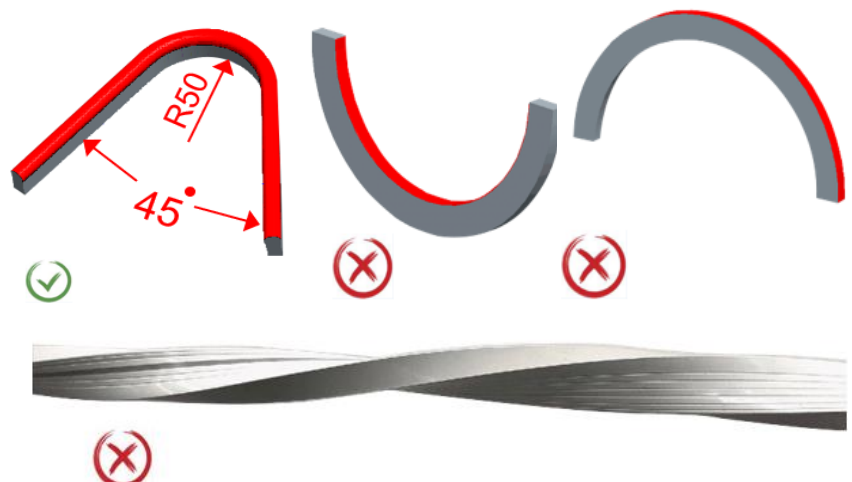

Parameter 基本参数

Model 型号:	LNTS8PW140NEON4-M1-D24-T0612	Luminous flux 光通量:	359±10%lm/m
Rated power 功率:	10.0W /m±10%	Efficiency 光效值:	35.9±10%lm /W
Total power 总功率:	18.6W±10% (2m)	Beam angle 发光角度:	120°
Input voltage 电压:	DC24V	Optimum length 首尾无亮差:	3m
LED type 灯珠类型:	SMD2835 140LED/M	Cutting Unit 最小剪裁单位:	50mm
Color 色温/波长:	6100±300K	IP rate 防水等级:	IP65
Ra 显示指数:	CRI>90	Working temp 工作温度:	-20°C~40°C

备注:

- ①.The test environment temperature is 25 ± 2 °C;测试环境温度为 25 ± 2 °C;
- ②.The above parameters correspond to specific samples, and the change of raw material parameters will cause fluctuations;以上参数对应特定样品, 更改原材料参数会出现波动;
- ③.The values of the parameters are typical values, and there are some errors in the normal range with the actual parameters of the samples.参数数值为典型值, 与样品实际参数有一定正常范围内的误差。
- ④.This product is guaranteed for 3 years, If you have any other questions, please contact the sales staff.
本产品的质保期为3年, 如有其它疑问, 请联系销售人员联系。

Drawings 尺寸图

Unit 单位: mm

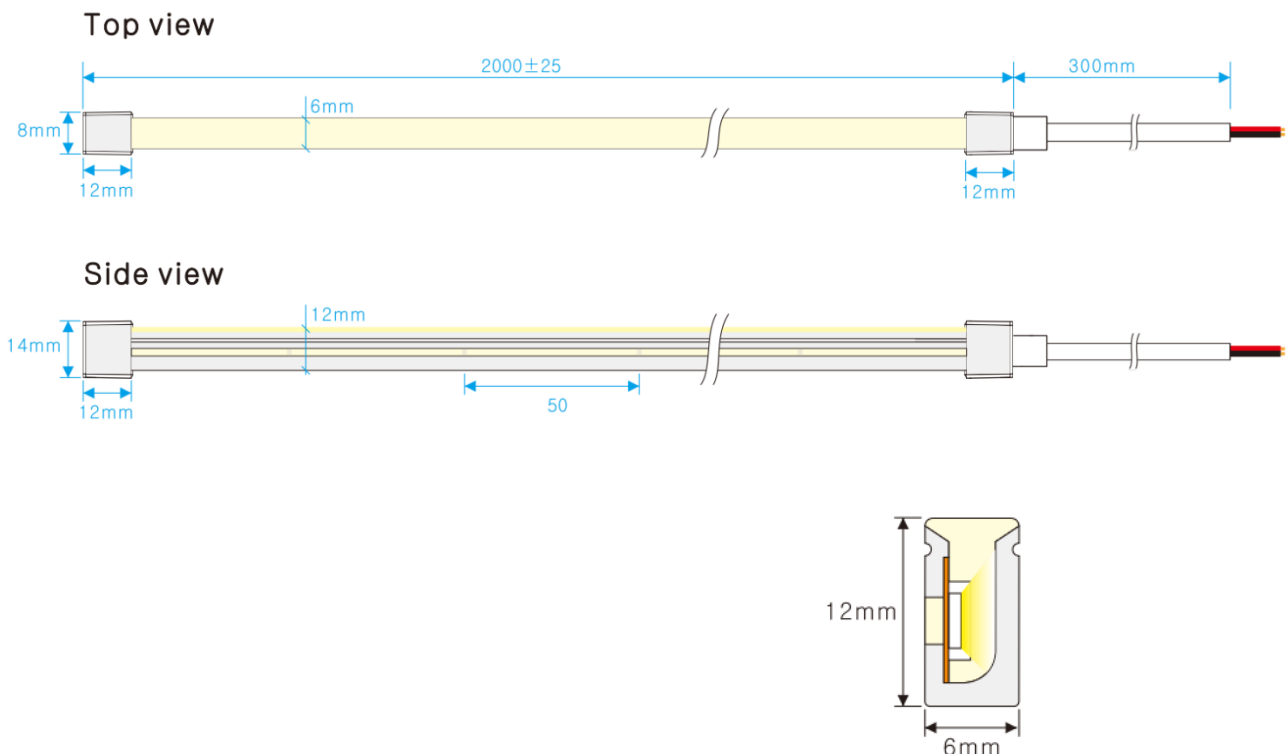

parameters of different length light strips 不同长度灯条典型光电参数

	参 数				
Length of strip 灯条长度	1m	2m	\	\	\
Working voltage 工作电压(V)	DC 24V	DC 24V	\	\	\
Total current 总电流(A)	0.418	0.776	\	\	\
Total power 总功率(W)	10.03	18.62	\	\	\
Head voltage 首端电压(V)	23.99	23.99	\	\	\
End voltage 尾端电压(V)	23.87	23.53	\	\	\
Voltage decay rate 首尾压衰率 (%)	0.50	1.92	\	\	\
Power supply 单/双端供电	single end 单端	single end 单端	\	\	\

Light distribution 样品配光曲

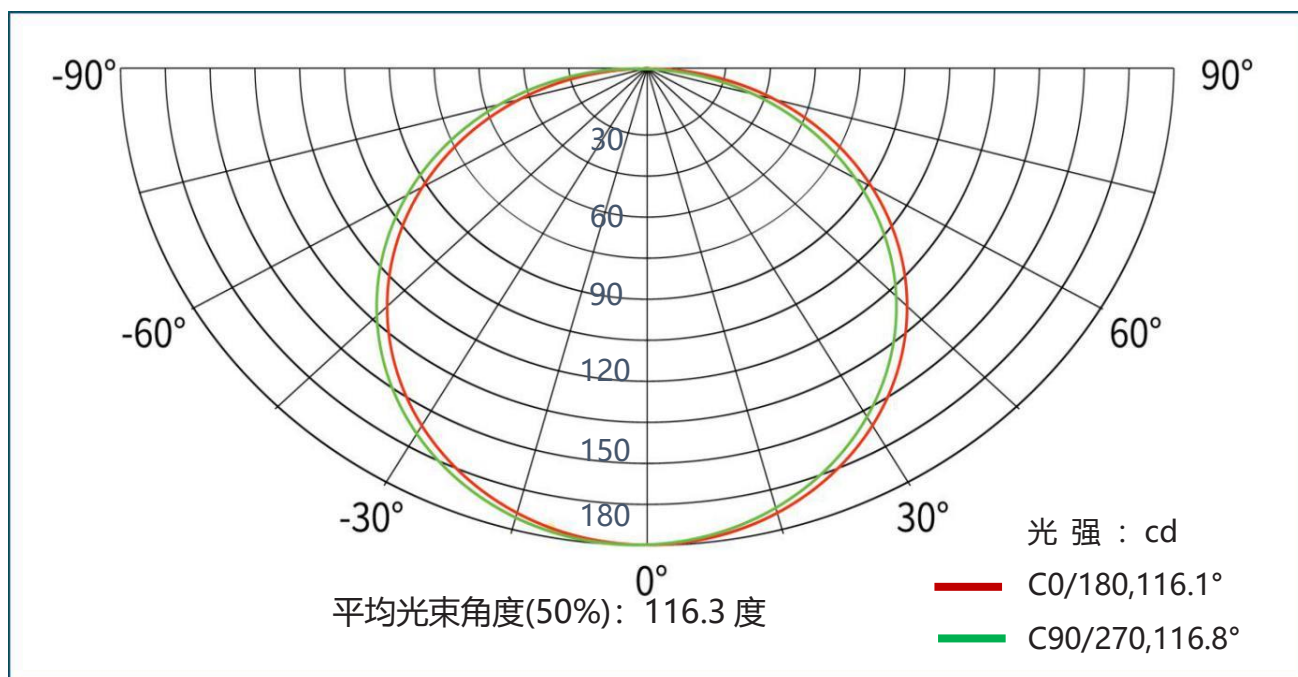

Note: the above is the test result when the lamp color temperature is 6100K. If you have any other questions, please contact the sales staff.

备注: 以上是灯珠色温 6100K 时测试所得, 如有其他疑问, 请联系销售人员联系。

Simple Connection Steps 免焊连接器接灯条示意图

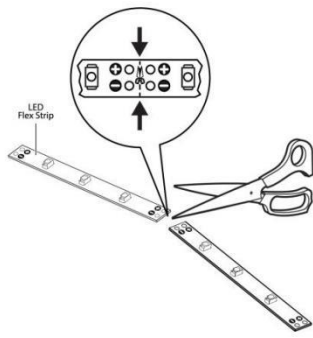

按照灯条上裁剪标识剪裁所需要的长度。
Cut along the light strip tape wherever a dashed line divides two sets of positive and negative connection points.

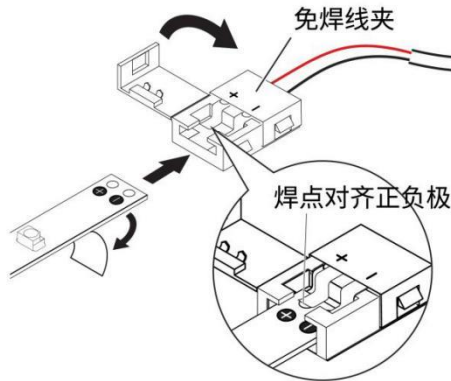

将灯条卡入免焊夹中。再合上铰链夹。
Peel away a portion of the light strip adhesive backing at one end. With the solderless clamp open, slide the strip end all the way into the solderless clamp. Close the hinged clamp.

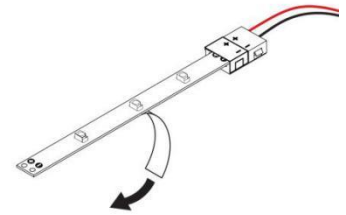

撕下双面胶把灯条粘贴在所需位置表面，再连接电源。
Remove the remaining adhesive backing and attach the light strip to the desired surface.

Common wiring diagram 常见接线示意以及说

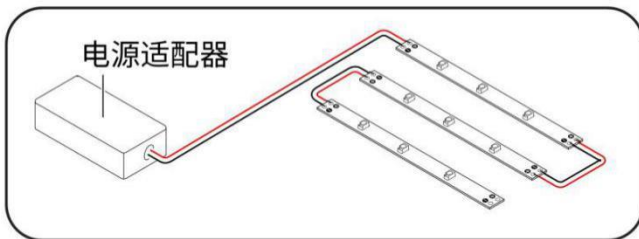

①Light strips are powered in a continuous 'Straight' run. Strips that are furthest from the power supply are more likely to exhibit voltage drop.
灯条连续'直线'接线。离电源最近的灯条更有可能出现压降现象。

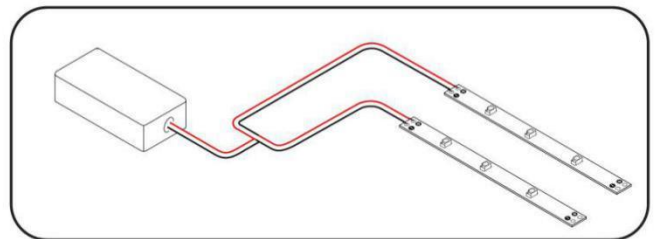

②Light strips are powered from a spliced 'Centerfeed' connection. This type of layout tends to produce more consistent brightness and color between strips.
灯带'并联'再连接电源。这种接线方式更有利于在条带点亮后拥有一致的亮度和颜色。

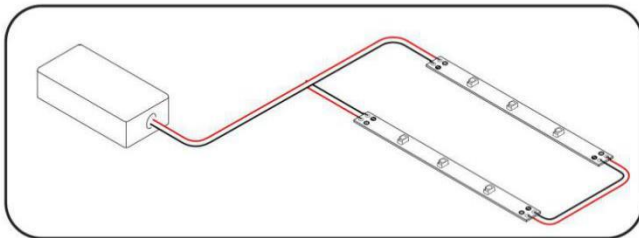

③Light strips are powered from a single looped 'Loopback' connection, which also produces more consistent results. Often used for room perimeter and cove
灯条由单环'回圈'连接供电，灯条点亮后颜色和亮度一致性更好。常用于房间周边和凹处布局。

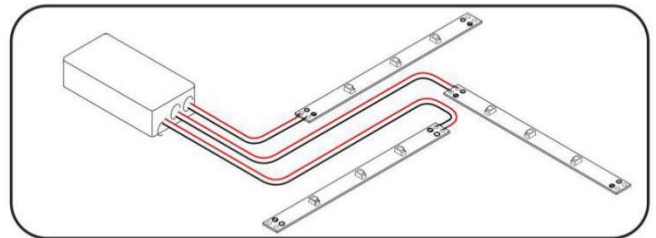

④In the 'Array' option, light strip 'legs' are individually powered. Total wattage should be determined so as not to overload power supply.
'阵列'接线，灯条是单独供电的。这种接线方式应确定总瓦数，以便不要让电源过载。

Product fault reference table 产品简单问题故障速查表

Fault phenomenon 故障现象	Possible reason 可能原因	Solution 解决方法
All the led are off 所有 LED 不亮	1.No electricity 市电没供电	Power transmission 送电
	2. Short /open circuit 电源输出端开路或短路, 引起电源自动保护	Check the circuit and remove the fault 排除故障, 重新送电
	3. The polarity is reversed 产品供电端极性接反	
Some LEDs are off 部分 LED 不亮	1. Some power supply not powered 部分电源没有供电	Check the power circuit and remove the fault 检查供电系统, 排除故障
	2. Some products's circuit is wrong 部分产品供电电路出错	
	3. Some products'polarity is reversed 个别产品极性接反	Connect the wires correctly 正确接线
Led Uneven brightness or low brightness LED 亮度不均或亮度不够	1. Power overload 电源超负荷	Increase the power load 增大电源负荷量
	2. Power consumption overload 电源输出端损耗过大	Ensure that the product operating voltage error is within $\pm 5\%$ of the standard 确保产品工作电压误差在标准电压的 $\pm 5\%$ 以内, 或保持电路各支路损耗保持平均
LED Flashing LED 闪烁	1. terminal not be connected correctly 接线点接触不良	Identify the fault point and remove the fault 找出故障点, 排除故障
	2. Power supply failure 电源故障	Ensure the working voltage error is within the standard voltage 确保产品工作电压误差在标准电压
	3. Products not used as required 未按要求使用产品	Make sure to follow the product instructions to use the product 确保遵照产品说明使用产品

Installation notes 注意事项

- ※Before installation, please check whether all of the parameters of the product are consistent with the requirements (refer to the product specifications). The working voltage, current and power of the power supply must be consistent with this product.
- ※It is strictly forbidden to disassemble or modify this product, and the surface of the led is forbidden to touch with sharp objects. During the installation process, Live operation is strictly prohibited.
- ※When fixing the product with neutral glass glue, the glue should be cured for more than 4 hours in a spacious and airy environment before being closed.
- ※Please follow the instruction for correct wiring to avoid short circuit during operation.
- ※For led strips, if the maximum cascade length is exceeded, it is necessary to perform offset electric charging.
- ※For led strips, if a single led exceeds the normal current, please add auxiliary heat dissipation.
- ※Installation, repair and maintenance must be performed by qualified electrician.
- ※使用的电源和负载的电压、电流、功率必须与本产品相符。
- ※严禁拆卸或修改此灯，灯珠表面禁止锐物触碰。
- ※使用中性玻璃胶固定产品时，须在宽敞并空气流通的环境中待胶体固化 4 小时以上，再进行封闭。
- ※请按接线图正确接线（先接负载再接电源，或送电）操作过程中注意避免短路。
- ※对于直条形不防水软条，超过最大级联长度，必须进行错位补电。
- ※对于直条形不防水软条，如果单灯珠超过常规电流使用，请增添辅助散热。
- ※电源和产品间的电源连线不能过长，如无特殊规定，一般为 2 米长， 否则线损增大，导致产品首尾端亮度不一致。
- ※安装、维修、保养必须是专业人员作业，严禁非专业人员作业。