

# AC230V LED Strip Light

Constant Current / Driverless / Over voltage Protection / Over heat Protection



**Guangzhou Linong Lighting Technology Co.,Ltd.**

## ADDRESS

Keying Rd,Guangzhou Sci-Tech Industry Park,  
Baiyun District,Guangzhou,China.

## CONTACT

Tel:+86-15920391130      Fax: +86-20-31232640  
Email:info@mylikeled.com      Web:www.mylikeled.com



# 1. Specification & Parameters

## 1.1. External Dimension

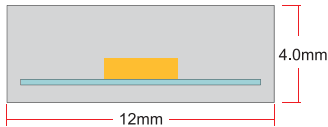

**Silicone Extrusion**

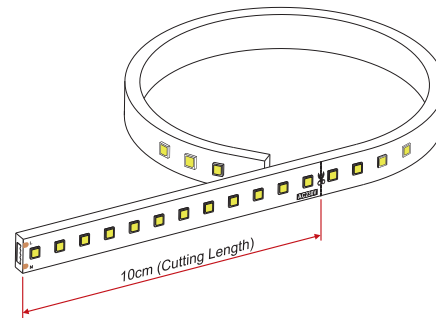

**Notice:**

Input Voltage Range: AC220V ~ AC240V.  
Size of each section is 10cm, and cutting at "black line" place.  
The dimension tolerance of height is  $\pm 0.3\text{mm}$ , and tolerance of width is  $\pm 0.3\text{mm}$ .

CE CERTIFIED	AC 230V INPUT	3-Step MacAdam	Bending Diameter	Flame Resistant	UV Resistant	Solvents Resistant	Saltwater Resistant	IP67 Protection	Beam Angle 150°	3 Years Warranty

## 1.2. Technical Parameters

Technical Data	
Product Code	LNTS8X120V0-AC230
Colour	W/NW/WW/CW
Working Voltage	AC220-AC240V, 50Hz
LED Qty/m	120LEDs /m
LED Type	SMD 2835
CRI	CRI>80      CRI>90
Rated Power/m	15W/m      15W/m
Light Efficiency $\pm 10\%$	110Lm/w      95Lm/w
LED Distance	8.33mm
Min. Cutting LED	12LEDs
Min. Cutting Length	10cm
Weight/m	120g
Storage Temperature	-25~60°C    (-13~140°F)
Environmental Working Temperature	-20~45°C    (-4~113°F)
IP Rating	IP67 (uncut)



## 1.2. Optical Parameters

Optical Data			Lumen/m		
Product Code	LNTS8X120V0-AC230		Rated CRI	CRI80	CRI90
Color	Wavelength	CCT			
Warm White	/	2725K±100K		1500 lm/m	1380 lm/m
Warm White	/	3045K±150K		1570 lm/m	1420 lm/m
Natural White	/	4000K±150K		1650 lm/m	1500 lm/m
Cool White	/	6500K±250K		1700 lm/m	1550 lm/m
RED	620-630nm	/	/	/	/
GREEN	520-530nm	/	/	/	/
BLUE	465-475nm	/	/	/	/
AMBER	585-595nm	/	/	/	/

Luminous Intensity Distribution

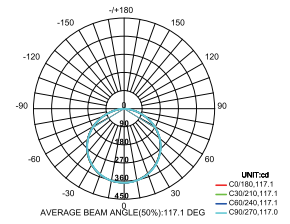

illumination diagram

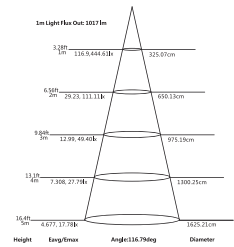

## 2. Types of Connector

### 2.1 Outdoor Use & IP65 Waterproof Connector

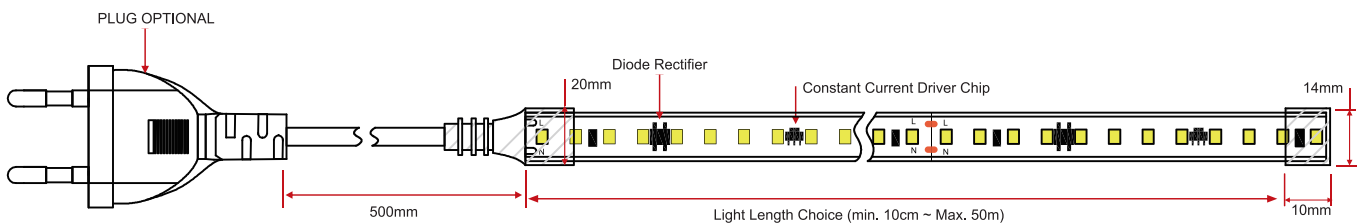

#### > Notes:

- **IP67 Outdoor Use:** Pls do not cut off the LED Tape light, and DIY cutting is not allow;
- All kinds of customized length of the light are available, from 10cm minimum ~ 50m maximum ;
- Do not submerge LED Tape light in any liquids, or use the light in the vicinity of standing water;
- Outdoor Application Scope: Outer Wall of building, Overbridge etc., and Suitable for raining environments;

**2.2 Indoor use & DIY IP65 Connector**



**Power Cord**

Connects light to power supply  
IP65 DIY connector (indoor use)

Rubber Cable Length available in 0.1m ~ 20m Max.

**Screwless Terminal, DIY assembly**

- DC Connector (2 Pin) \*1
- Anti-tension Shell \*1
- PC Fixing Clip \*1

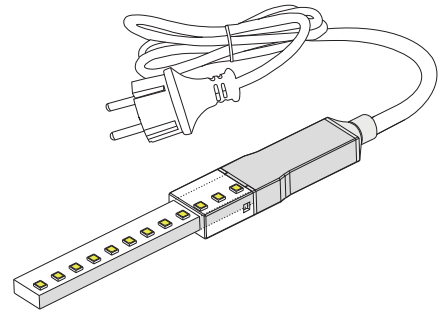

**Docking Connector**

Combine two pieces of the lights together  
IP65 DIY connector (indoor use)

**Seamless Docking, Screwless Terminal**

- Anti-tension Shell \*1
- Feed Connector (2 Pin) \*1
- PC Fixing Clip \*2

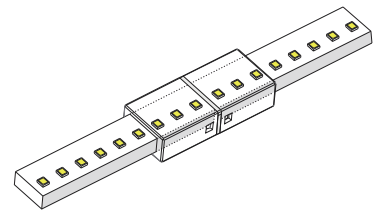

**End Cap**

Termination Protection of the light,  
IP65 DIY connector (indoor use)

**Screwless Terminal, DIY assembly**

- Anti-tension Shell \*1
- PC Fixing Clip \*1

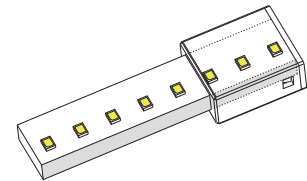

**> Notes:**

- Before making any cuts, installation, maintenance or connection, and be sure the light is power-off!
- **IP67 Indoor Use:** Pls cut the light and assemble all connectors according to the instruction manual;
- Don't install and light up and use the light under water. Only IP65 indoor application places can be used for this light;
- Indoor Application Scope: Cove of Theater / hotel lobby etc., and Suitable for damp environments(e.g. Toilet, Balcony Cove etc.);

### 3. Installation & Profile

#### 3.1 Mounting Profile

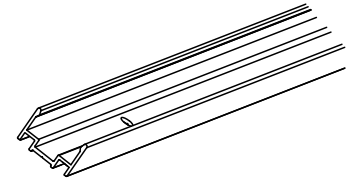
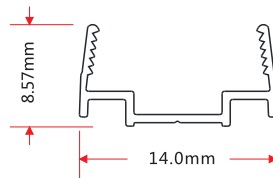
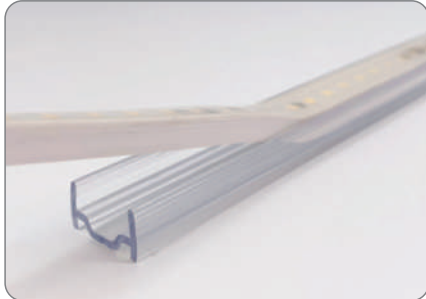

Code	W*H(ft)	Profile Length(mm)	Hole Size (mm)	Hole Number (pcs)
LNTS8X120V0-AC220-PC	14mm * 8.57mm	1000mm	Φ3.5mm	3
		1500mm	Φ3.5mm	4

**Notes:**

1. The raw material is plastic PC, 100% transparent, and Any customized Length available too, such as 0.5m or 1m or 2m length maximum;
2. Each 0.3m length with 1 hole and 1 screw, and installation referce to the user manual;

#### 3.2 Mounting Clip

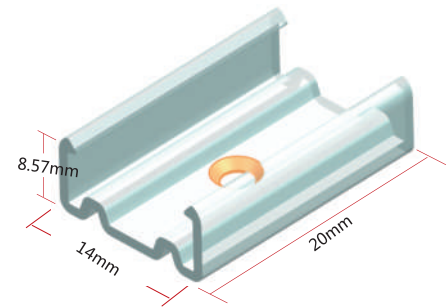
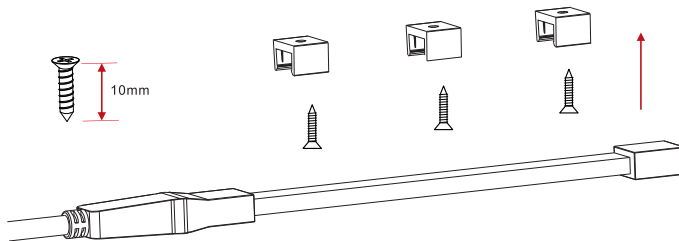

**Notes:**

1. Mounting Clip's raw material is PC, and transparent/white/black/red paint available;
2. Each 0.3m length with 1 Mounting Clip + 1 screw, and installation referce to the user manual;

## 4. Packaging

#### 4.1 Packaging for retails

	Light Length (m/one roll)	Carton Dimension (cm)	Light Number (rolls)	Carton Weight (kg)
	20m	25*21*33	1 roll	3.5
	30m	31*23*39	1 roll	4.8
	40m	31*23*39	1 roll	6.2
	50m	34*27*43	1 roll	7.9

### 4.2 Packaging for Distributors



### 4.3 Packaging for Projects

